



Setting New Standards in Laboratory & Industrial Weighing— The Next Generation of Scout Balances

Ideal for laboratory and industrial applications, the OHAUS Scout comes in a slim, stackable design with large backlit LCD. Features include superior overload protection, multiple weighing units and application modes. Geared for high performance in your facility with fast stabilization time and high resolution weighing results, these portable balances set a new standard in laboratory and industrial weighing.

Standard Features Include:

- **Bright Backlit LCD & 4 Button Control Enable Efficient Operation and Ease of Use**
Combined with a simplified 4 button operation, the Scout's large backlit display increases readability in low light working conditions, and is easier to view from a distance.
- **Bolstered by Superior Overload Protection and Impact-Resistant Pan Support**
Integrated superior overload protection and impact-resistant pan support safeguard against shock and overloading the balance in rugged and demanding environments.
- **Better Performance and Higher Capacities Widen the Range of Weighing Applications**
Stabilization time as fast as 1 sec and advanced weighing technology, lead to improved productivity in your facility. Increased capacity unlocks a wider range of weighing applications.

Scout® Portable Balances

Improved Experience with Backlit Display and 4 Button Operation

Poor lighting environment is not an issue with the Scout. The large, bright backlit LCD display improves readability in conditions where lighting is poor, and makes it easy to see the results from a distance. 4 clearly marked buttons remove complexity, and guide you quickly and easily through setup, unit of measure changes, calibration and more.

Durability Guaranteed with Superior Protective Features

The Scout equipped with superior overload protection rated at 10 times the capacity of the balance, high strength stainless steel pan, impact-resistant pan support and integrated transportation/storage lock, delivers the same durable quality that you expect from OHAUS products. To complement our signature durability, we've designed the Scout to be stackable when utilizing the optional stacking and storage cover, which also protects the balance when not in use.

Most Versatile Portable Balance in its Class

With the Scout, it's all about accuracy, efficiency and possibilities! Stabilization time as fast as 1 sec means increased productivity in any facility or lab. With improved resolution, you can count on extremely precise and repeatable weighing results. Additionally, the increased capacity of the Scout gives you more flexibility in your weighing applications.

Draftshield Model Available

Scout's ingenious draftshield (1mg models only) was designed with an easy to remove top cover piece. This serves as a wind protection ring which keeps the weighing surface stable in rough environments, while maintaining weighing speed.

Built-in Application Modes

- **Weighing**—Determines the weight of items on the pan in the selected unit of measure.
- **Parts Counting**—Counts the number of pieces on the pan using a uniform weight.
- **Percent Weighing**—Measures the weight of a sample displayed as a percentage of a pre-established reference weight.
- **Check Weighing**—Compares the weight of a sample against target limits.
- **Totalization**—Measures cumulative weight of multiple items. Cumulative total may exceed balance capacity.
- **Display Hold**—Manually holds the last stable weight or the first highest stable weighing value on the display.

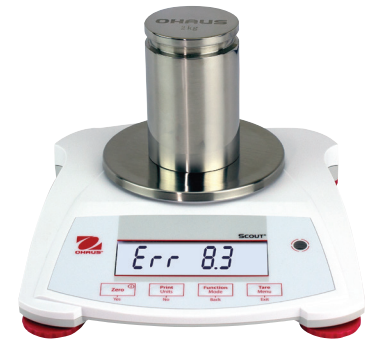



Draftshield
Protects the sample from external influences, increasing the speed and repeatability of measurements



Connectivity
Expanded connectivity options including RS232, USB Host, USB Device, Ethernet and Bluetooth®



Security Slot
Integrated security slot prevents theft



Weigh Below Hook
The integral weigh below hook on the bottom of the Scout allows for density determination or specific gravity calculations



Large Backlit LCD Display
High contrast LCD Display shows weight and application data clearly, even in poor lighting conditions



Lockswitch
The Scout can be locked into a specific configuration using the lockswitch

Capacity & Readability by Weighing Unit

Model	SPX123	SPX223	SPX222	SPX422	SPX622	SPX1202	SPX2202	SPX421	SPX621	SPX2201	SPX6201	SPX8200
Gram (g)	120 × 0.001	220 × 0.001	220 × 0.01	420 × 0.01	620 × 0.01	1200 × 0.01	2200 × 0.01	420 × 0.1	620 × 0.1	2200 × 0.1	6200 × 0.1	8200 × 1
Kilogram (kg)	/	/	/	/	/	1.2 × 0.00001	2.2 × 0.00001	/	/	2.2 × 0.0001	6.2 × 0.0001	8.2 × 0.001
Carat (ct)	600 × 0.005	1100 × 0.005	1100 × 0.05	2100 × 0.05	3100 × 0.05	6000 × 0.05	11000 × 0.05	2100 × 0.5	3100 × 0.5	11000 × 0.5	31000 × 0.5	41000 × 5
Newton (N)	1.17679 × 0.00001	2.15744 × 0.00001	2.1574 × 0.0001	4.1188 × 0.0001	6.0801 × 0.0001	11.7679 × 0.0001	21.5744 × 0.0001	4.119 × 0.001	6.080 × 0.001	21.574 × 0.001	60.801 × 0.001	80.41 × 0.01
Ounce (oz)	4.23290 × 0.00005	7.76030 × 0.00005	7.7600 × 0.0005	14.8150 × 0.0005	21.8700 × 0.0005	42.3290 × 0.0005	77.6030 × 0.0005	14.815 × 0.005	21.870 × 0.005	77.600 × 0.005	218.700 × 0.005	289.25 × 0.05
Ounce Troy (ozt)	3.85810 × 0.00005	7.07320 × 0.00005	7.0730 × 0.0005	13.5030 × 0.0005	19.9335 × 0.0005	38.5810 × 0.0005	70.7320 × 0.0005	13.500 × 0.005	19.930 × 0.005	70.730 × 0.005	199.335 × 0.005	263.60 × 0.05
Pennyweight (dwt)	77.162 × 0.001	141.463 × 0.001	141.46 × 0.01	270.07 × 0.01	398.67 × 0.01	771.62 × 0.01	1414.63 × 0.01	270.1 × 0.1	398.7 × 0.1	1414.6 × 0.1	3986.7 × 0.1	5270 × 1
Pound (lb)	/	/	/	/	1.36690 × 0.00005	2.64555 × 0.00005	4.85020 × 0.00005	/	1.3670 × 0.0005	4.8500 × 0.0005	13.6685 × 0.0005	18.080 × 0.005
Pound:Ounce (lb:oz)	/	/	/	/	1lb:5.8700oz × 0.0005oz	2lb:10.3290oz × 0.0005oz	4lb:13.6030oz × 0.0005oz	/	1lb:5.870oz × 0.005oz	4lb:13.600oz × 0.005oz	13lb:10.700oz × 0.005oz	18lb:1.25oz × 0.05oz
Grain (grn)	1851.88 × 0.02	3395.12 × 0.02	3395.0 × 0.2	6481.6 × 0.2	9568.0 × 0.2	18518.8 × 0.2	33951.2 × 0.2	6480 × 2	9570 × 2	33950 × 2	95680 × 2	126540 × 20

Outline Dimensions

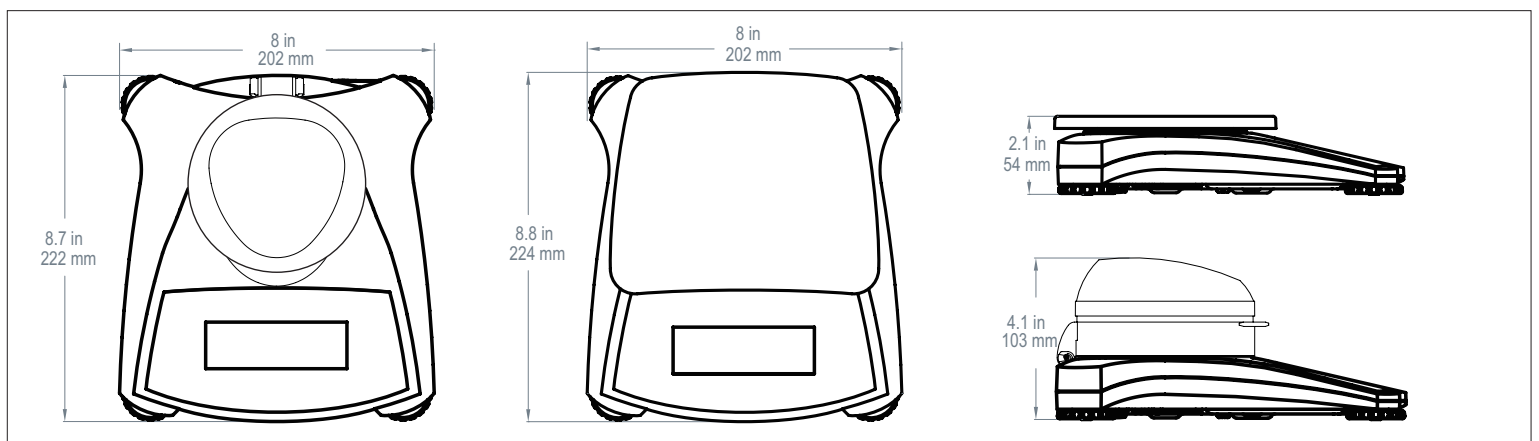

Scout® Portable Balances

Model	SPX123	SPX223	SPX222	SPX422	SPX622	SPX1202	SPX2202	SPX421	SPX621	SPX2201	SPX6201	SPX8200
Capacity (g)	120	220	220	420	620	1200	2200	420	620	2200	6200	8200
Readability (g)	0.001	0.001	0.01	0.01	0.01	0.01	0.01	0.1	0.1	0.1	0.1	1
Repeatability (Std. Dev.) (g)	0.002	0.002	0.01	0.01	0.01	0.02	0.02	0.1	0.1	0.1	0.1	1
Linearity (g)	0.003	0.003	0.01	0.01	0.02	0.03	0.03	0.1	0.1	0.1	0.2	1
Span Calibration Mass*	100 g	200 g	200 g	200 g	300 g	1 kg	2 kg	200 g	300 g	2 kg	5 kg	8 kg
Linearity Calibration Mass	50, 100 g	100, 200 g	100, 200 g	200, 400 g	300, 600 g	500g, 1 kg	1 kg, 2 kg	200, 400 g	300, 600 g	1 kg, 2 kg	3 kg, 6 kg	4 kg, 8 kg
Stabilization Time (s)	1.5	1.5	1	1	1	1.5	1.5	1	1	1	1	1
Construction	ABS housing & stainless steel pan											
Draftshield	Yes			No								
Calibration	User-selectable external span or linearity calibration/Digital with external weight											
Tare Range	Full capacity by subtraction											
Weighing Units	g, kg, ct, N, oz, ozt, dwt, lb, lb:oz, grn											
Application Modes	Weighing, Parts Counting, Percent Weighing, Check Weighing, Totalization, Display Hold											
Power Requirement	AC adapter (included) or 4 AA batteries (not included)											
Typical Battery Life (Hours)	80		120		80			120		80		120
Communication	RS232, USB Host, USB Device, Ethernet or Bluetooth® (available as an accessory)											
Display Type	Liquid crystal display (LCD) with backlight											
Display Size	0.78 in/20 mm digits											
Overload Capacity	10 times rated capacity											
Operating Temperature Range	50°F / 10°C to 104°F / 40°C at 10% to 80% relative humidity, non-condensing											
Storage Conditions	-20°C (-4°F) to 55°C (131°F) at 10% to 90% relative humidity, non-condensing											
Pan Size (W x D)	Ø3.7in/ 93 mm		Ø4.7in/ 120 mm			6.7 x 5.5 in/ 170 x 140 mm		Ø4.7 in/ 120 mm		6.7 x 5.5 in/ 170 x 140 mm		
Balance Dimensions (W x D x H)	8 x 8.7 x 4.1 in/ 202 x 222 x 103 mm				8 x 8.8 x 2.1 in/ 202 x 224 x 54 mm							
Shipping Dimensions (W x D x H)	11.8 x 9.8 x 5.1 in/ 300 x 250 x 129 mm				11.8 x 9.8 x 3.4 in / 300 x 250 x 86 mm							
Net Weight	2.2 lb/1 kg											
Shipping Weight	3.3 lb/1.5 kg											

* Span calibration weight is included with models up to 620g capacity.

Other Standard Features and Equipment

Transportation lock, stainless steel pan, menu & calibration lockout switch, slip-resistant and adjustable feet, leveling bubble, mechanical and software overload/underload protection, stability indicator, auto tare, low battery indicator, auto shut-off, user-selectable printing options, user-selectable communication settings

Compliance

- **Product Safety:** IEC/EN 61010-1; CAN/CSA C22.2 No. 61010-1; UL Std. No. 61010-1
- **Electromagnetic Compatibility:** IEC/EN 61326-1 Class B; FCC Part 15 Class B; Industry Canada ICES-003 Class B

Accessories

RS232 Interface Kit	30268982
USB Host Interface Kit (for Flash Drive)	30268983
USB Device Interface Kit (for PC)	30268984
Bluetooth Interface Kit	30268985
Ethernet Interface Kit	30268986
Stacking & Storage Cover* (6 pcs)	30268987
Stacking & Storage Cover* (1 pc)	30268988
Printer, Impact, SF40A, AM	30064203
Auxiliary Display, AD7-MD	30472063
Security Device	80850043
Carrying Case	30269021
In-use Cover	30269022
Adapter, 5V 1A US, Fixed Plug	30330714

*Not fit for models with draftshield

80774942_E 20181107 © Copyright OHAUS Corporation

OHAUS CORPORATION
7 Campus Drive
Suite 310
Parsippany, NJ 07054 USA

Tel: 800.672.7722
973.377.9000
Fax: 973.944.7177

www.ohaus.com

The management system governing the manufacture of this product is ISO 9001:2015 certified.

